

Ziffern 0 bis 9

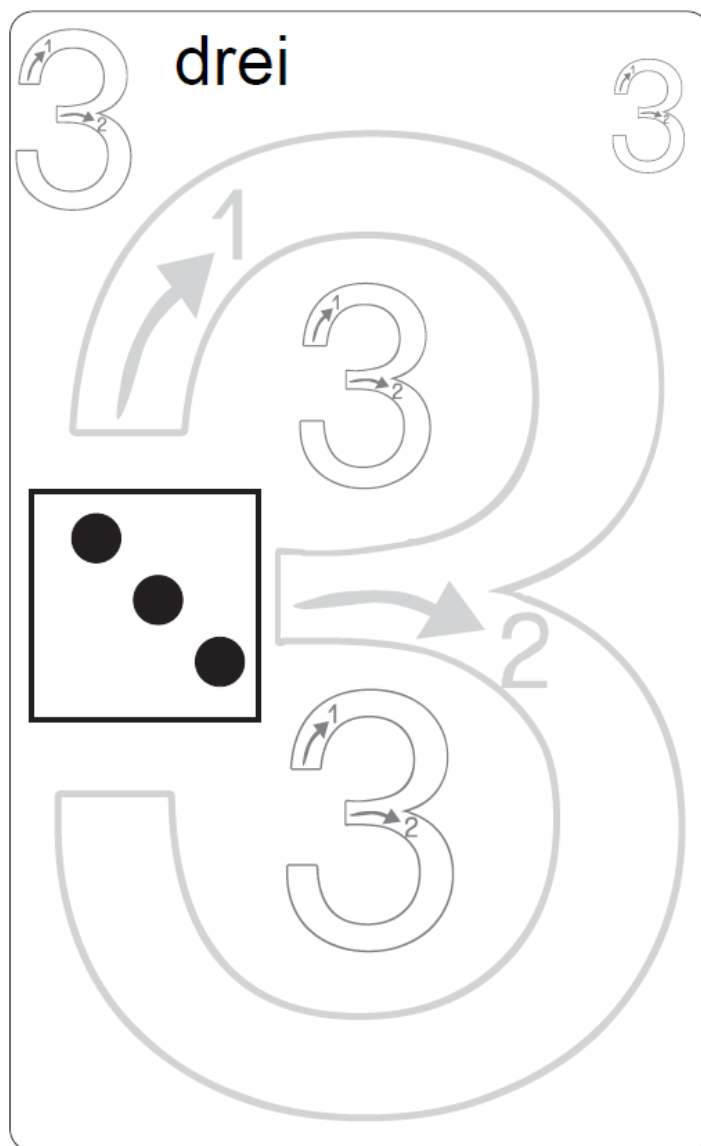

schreiben der Ziffern 0 - 9

NULL

NICHTS

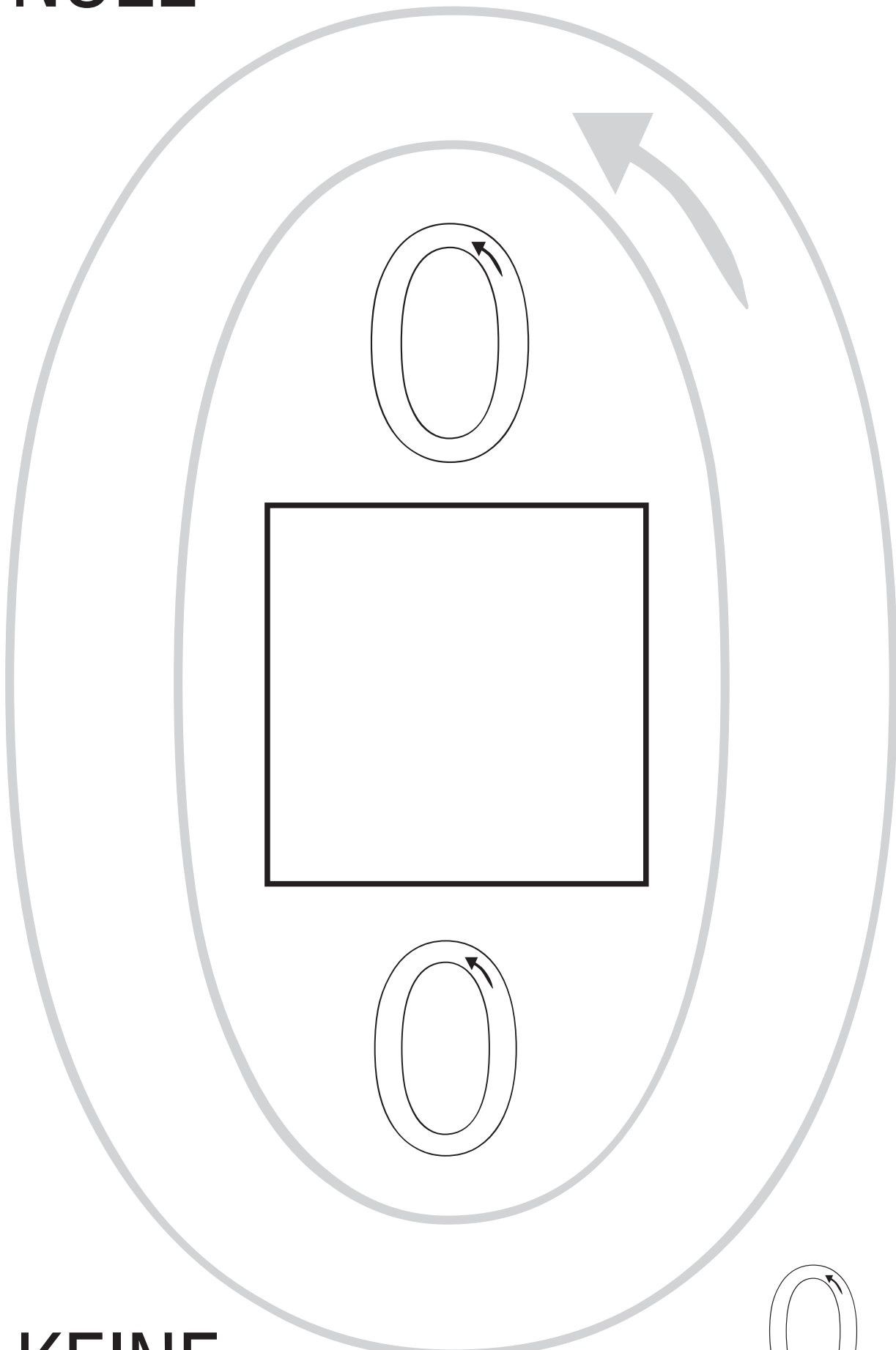

KEINE

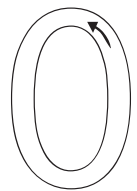

eins

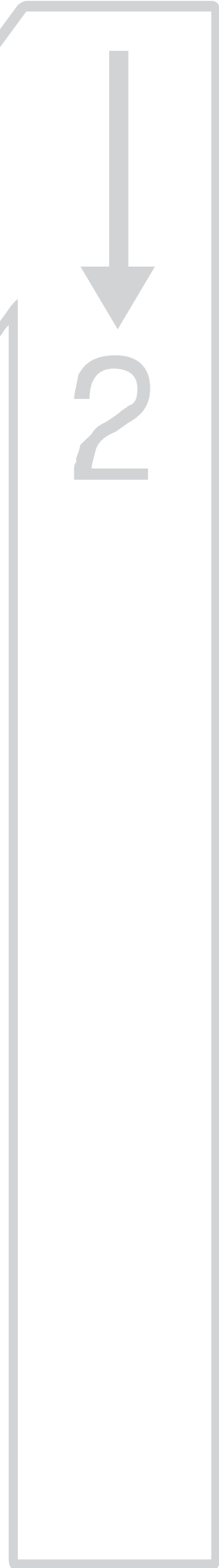
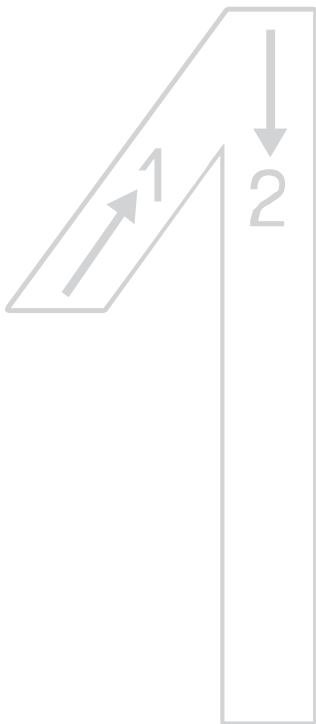
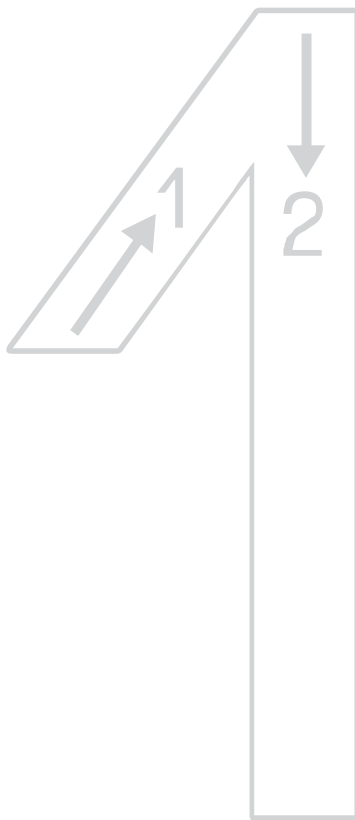
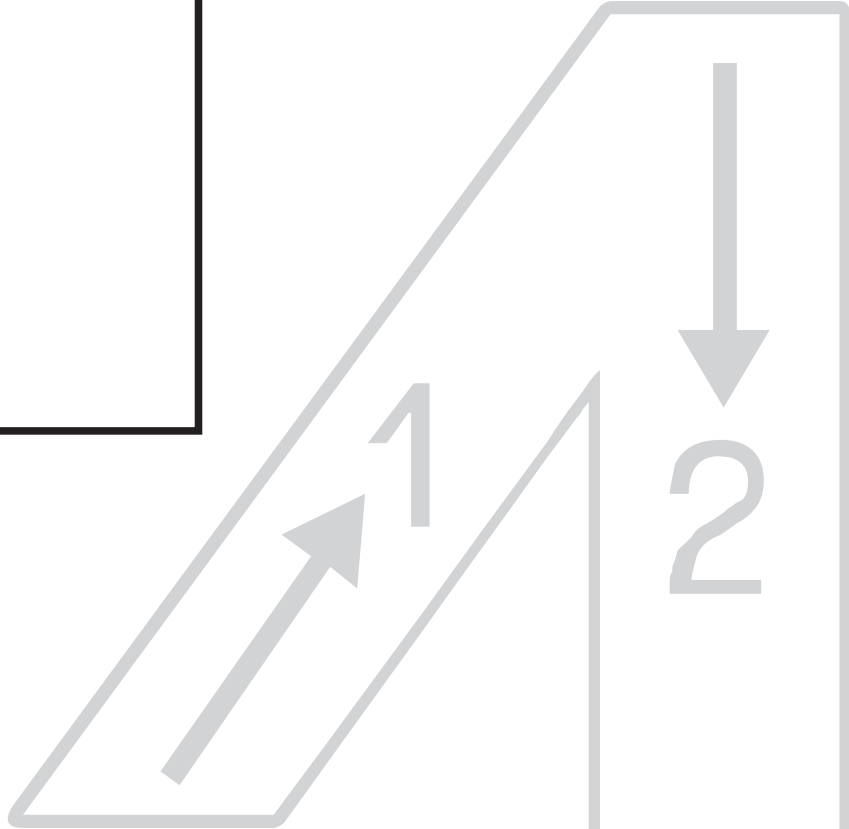
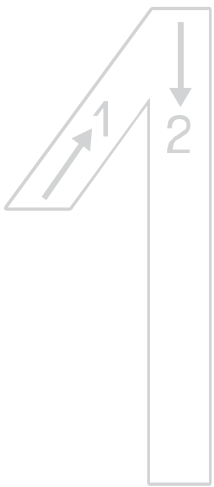
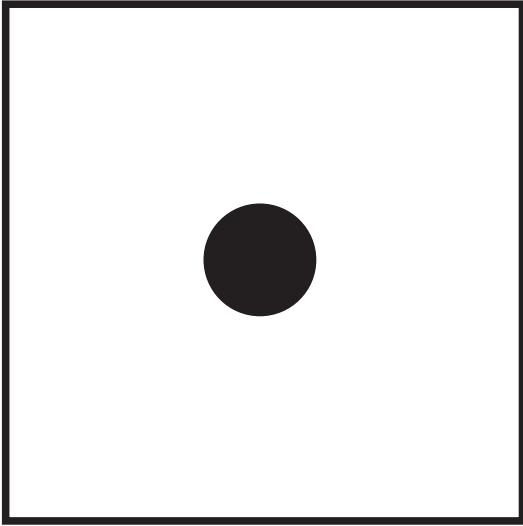

Streiche falsche 1 durch!

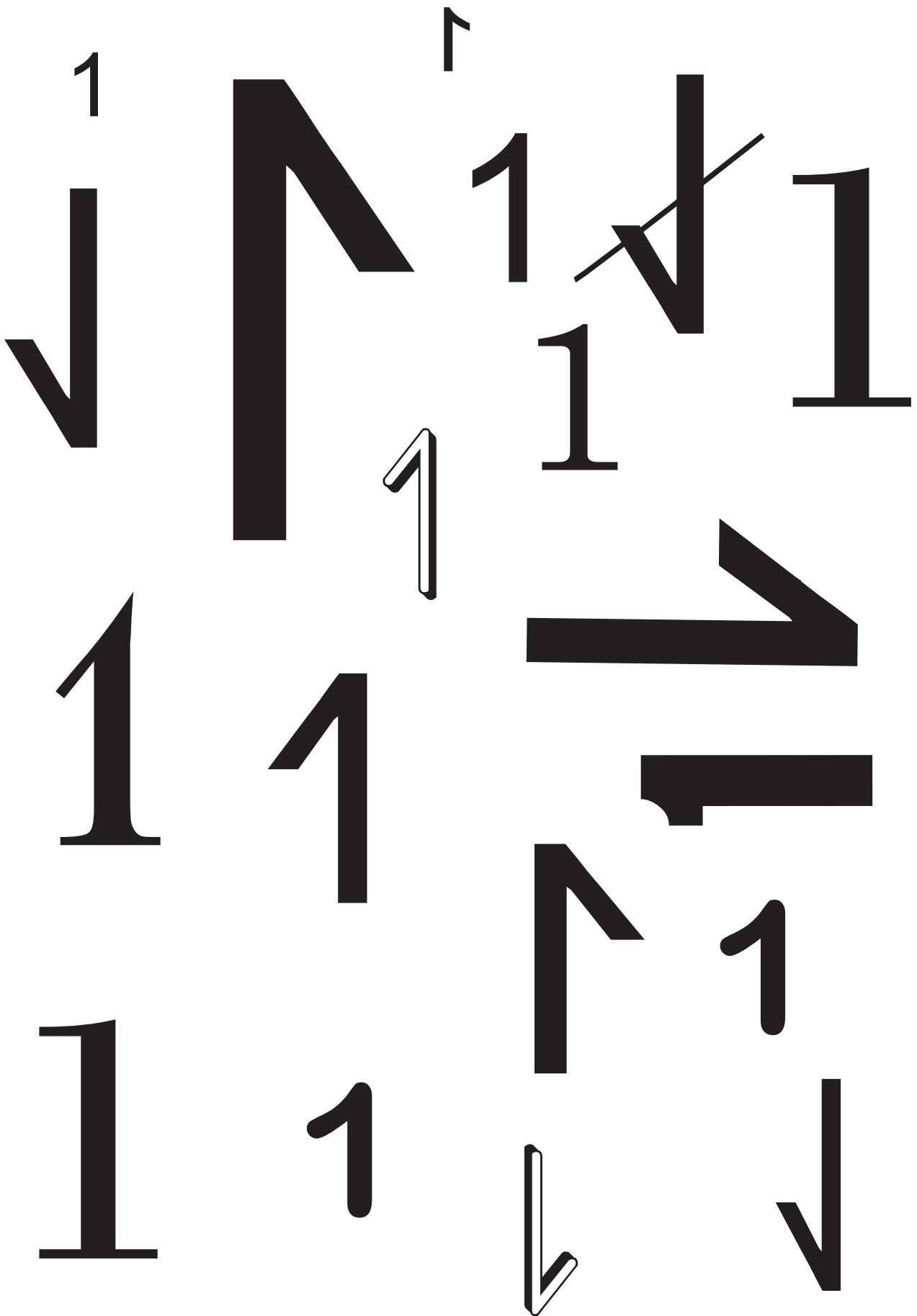

zwei

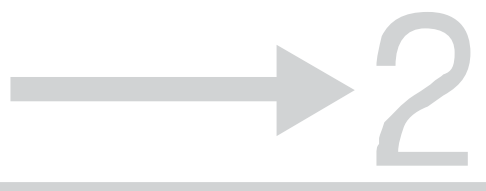
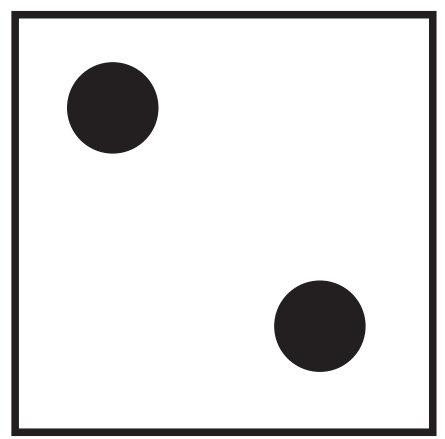
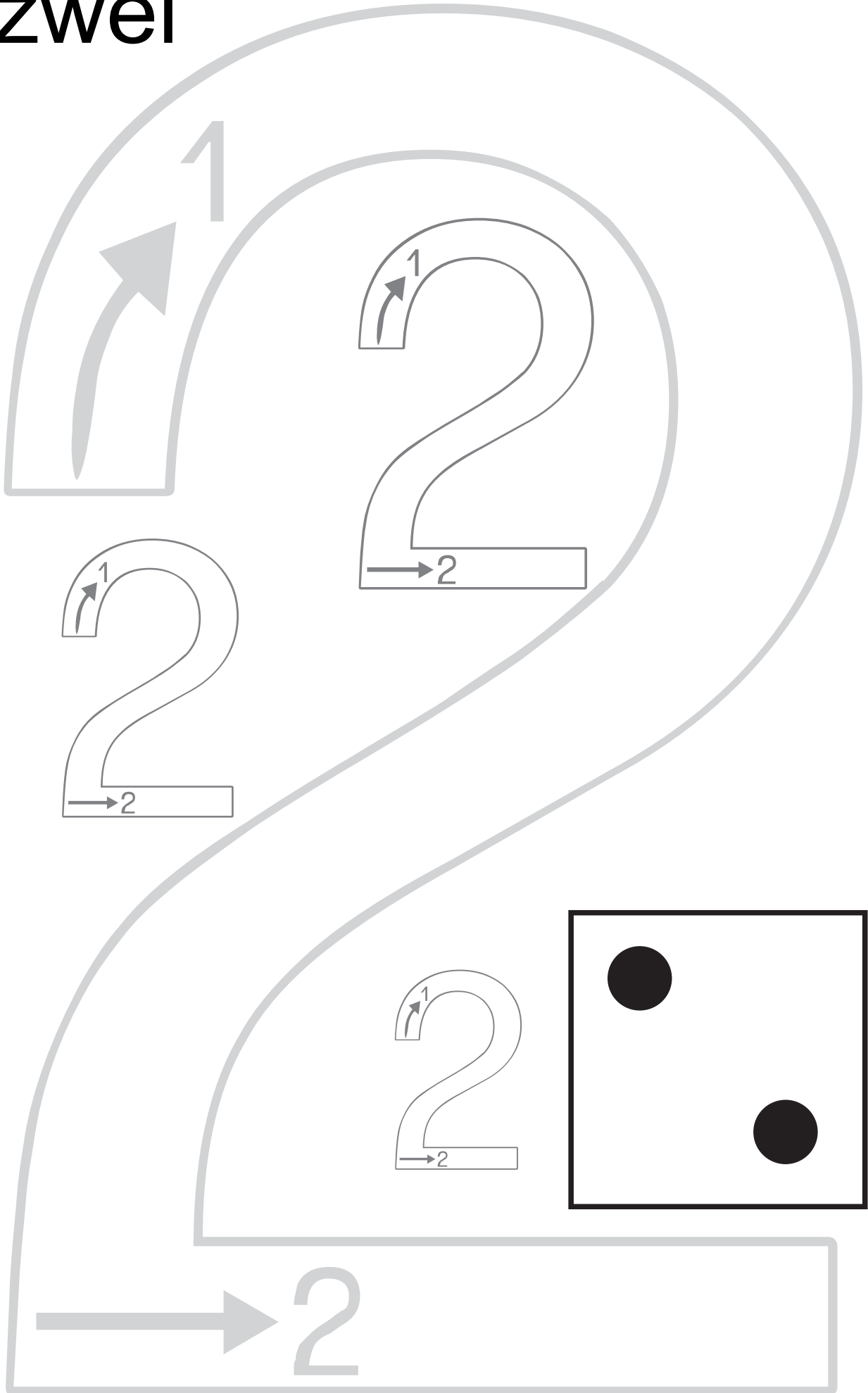

Aus einem mach 2!

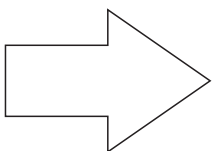
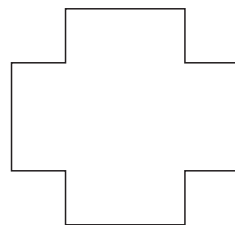
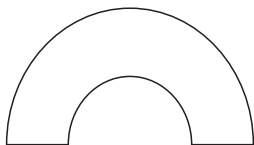
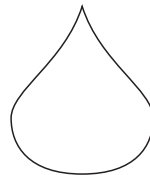
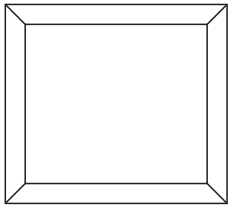
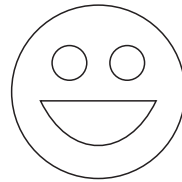
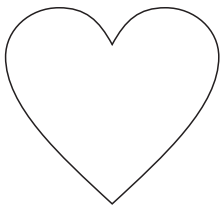
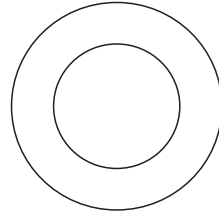
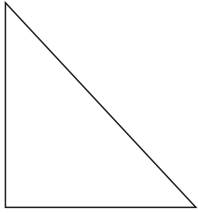
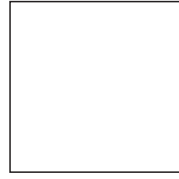
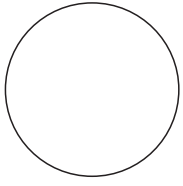

drei

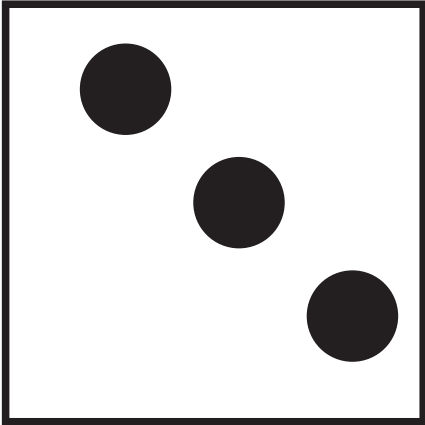
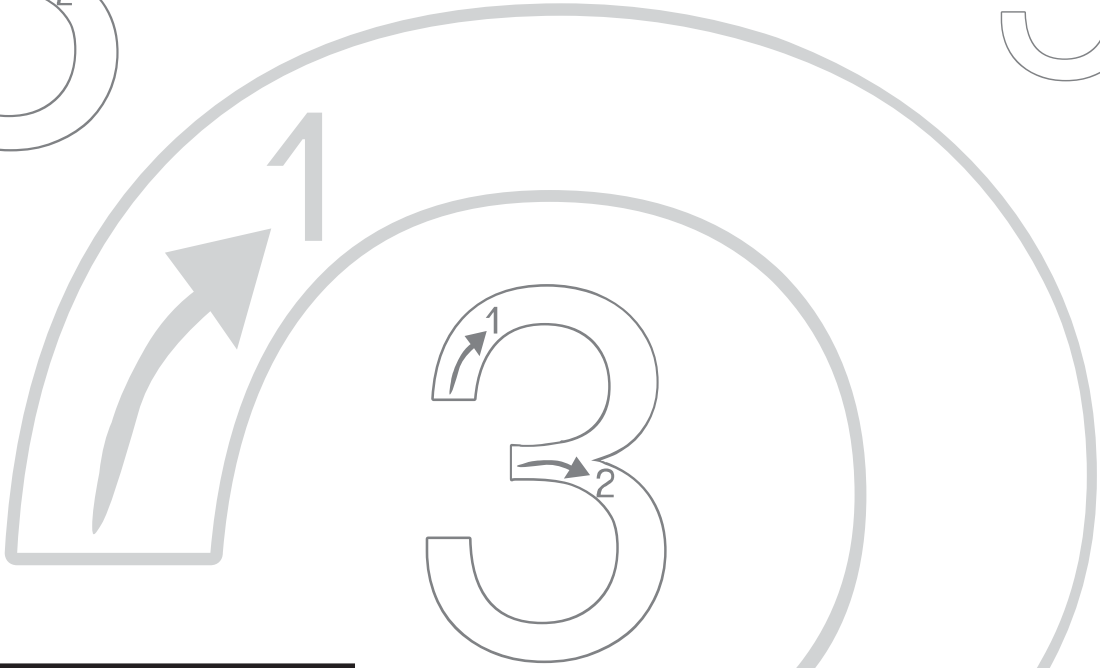
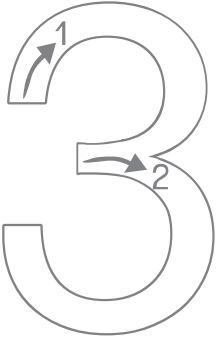

Packe immer 3 in einen Sack!

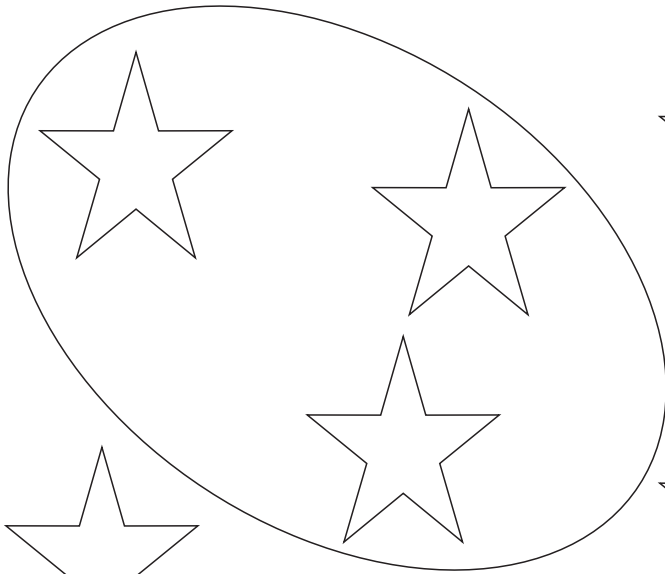

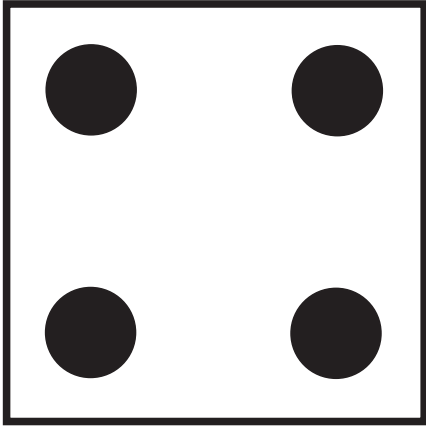

vier

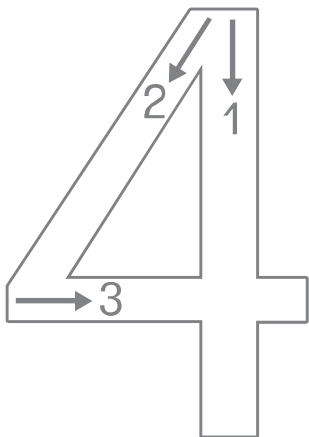
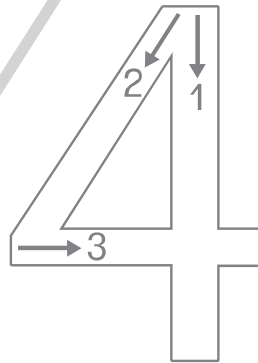
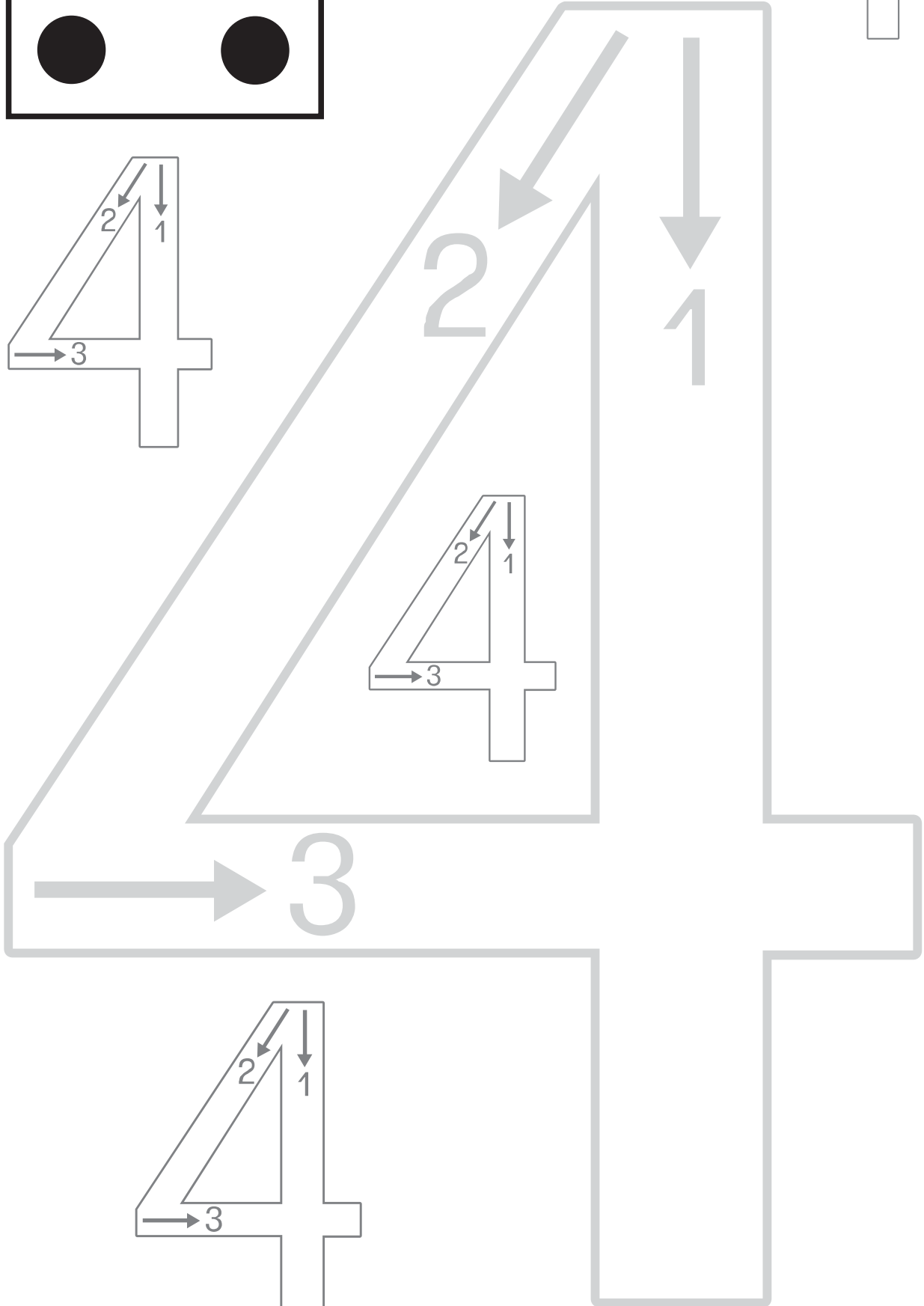
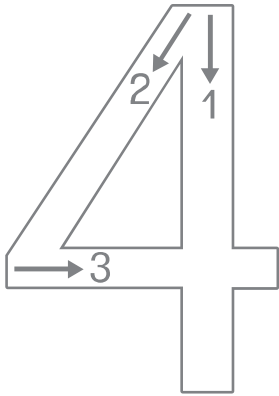
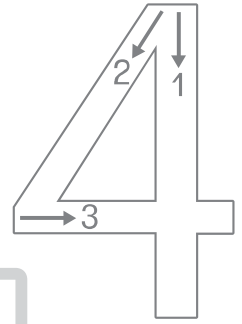

Schreibe die Zahlen!

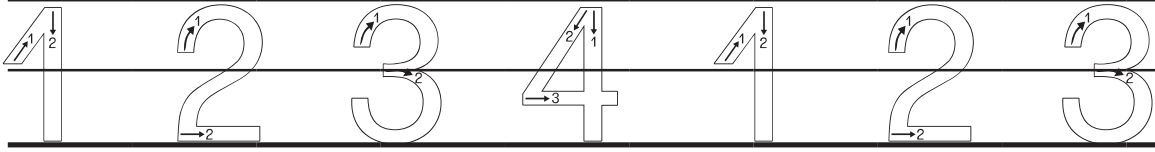

Blank handwriting practice lines consisting of four horizontal lines per row, with a thick middle line. There are 10 such rows available for writing practice.

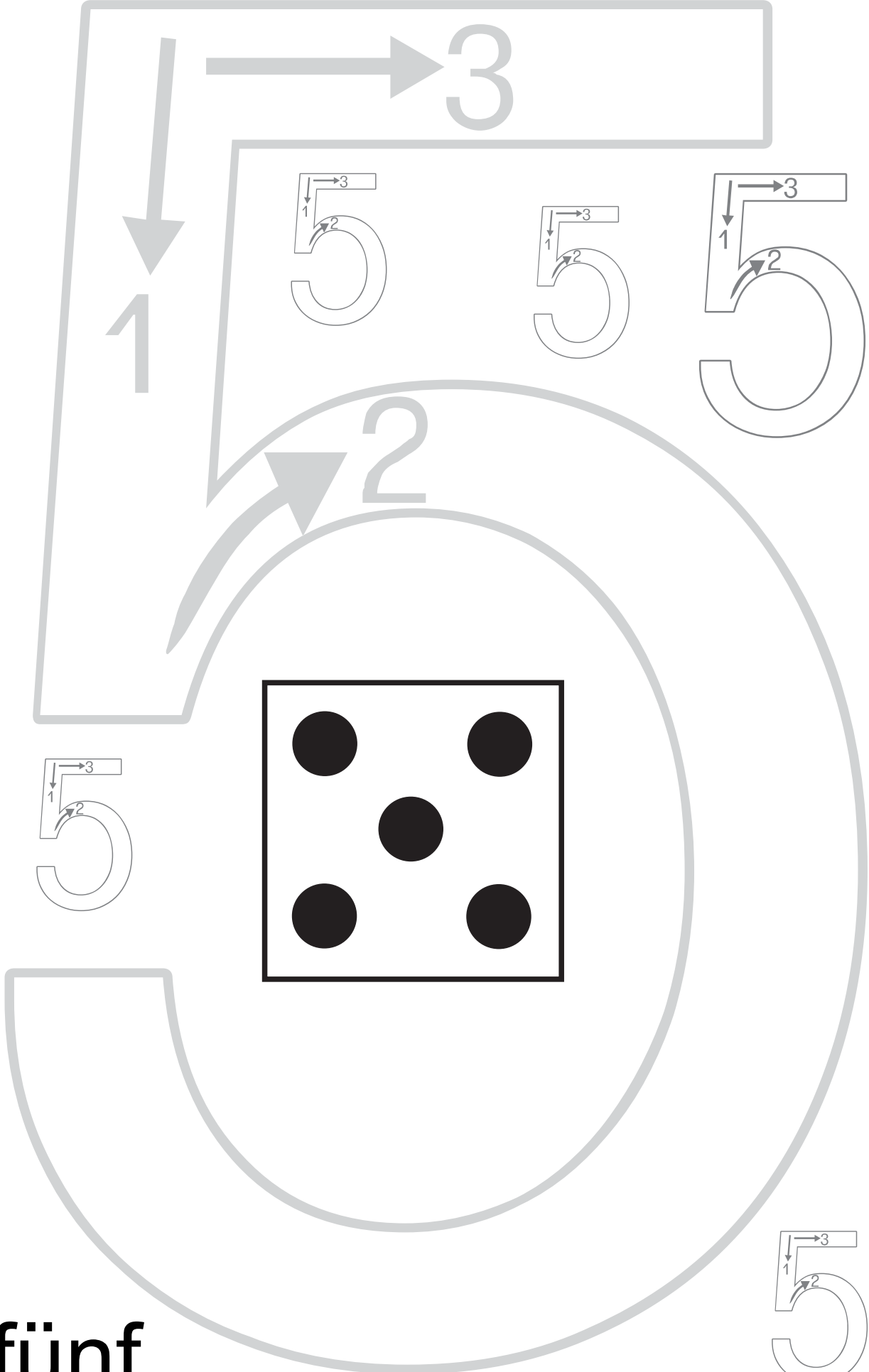

fünf

Wie viel fehlen bis 5?

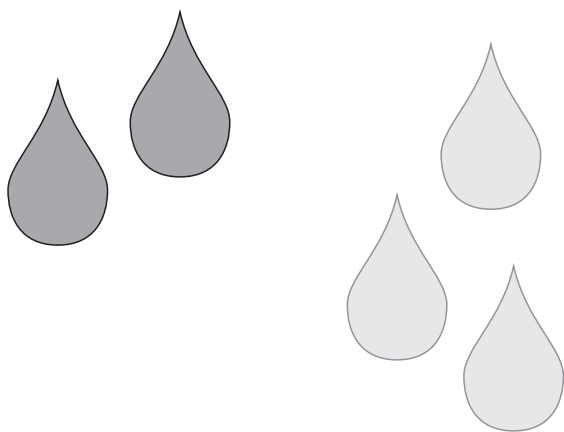

$$2 + \boxed{3}$$



$$1 + \boxed{}$$

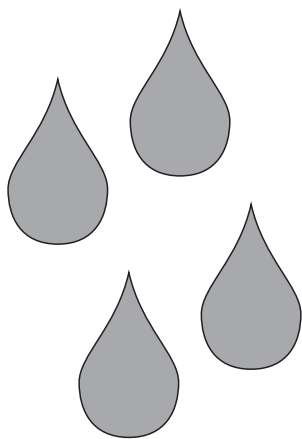

$$4 + \boxed{}$$

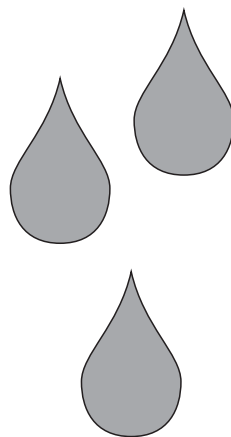

$$3 + \boxed{}$$

$$0 + \boxed{}$$

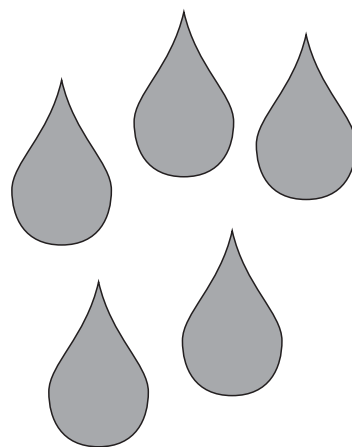

$$5 + \boxed{}$$

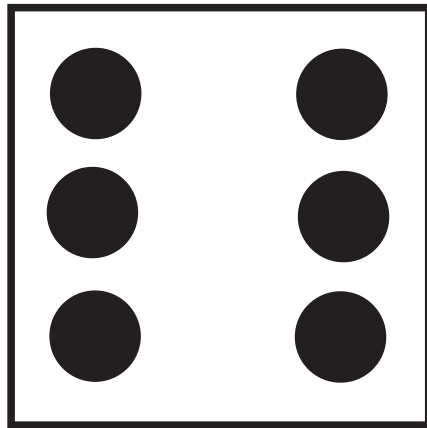
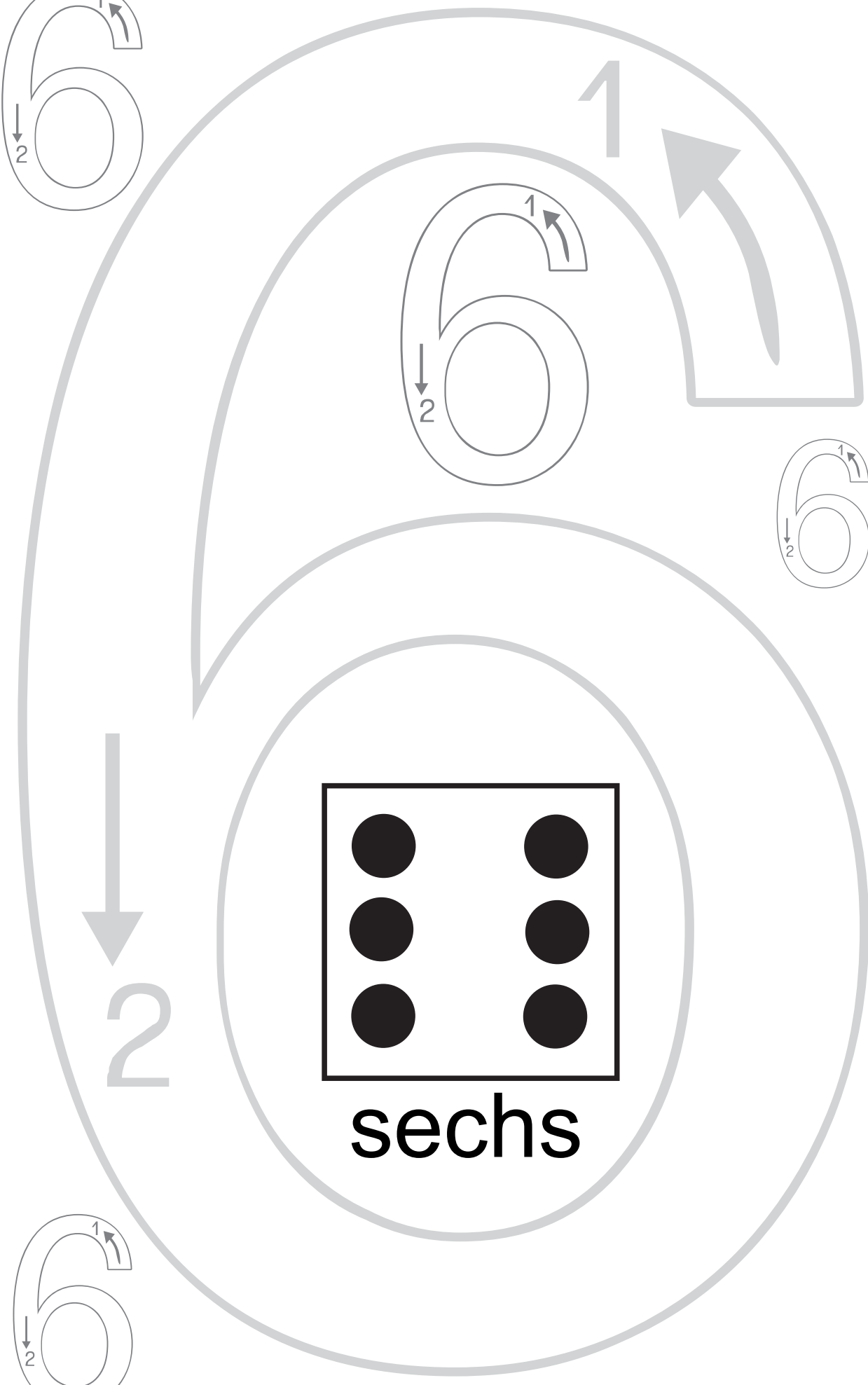
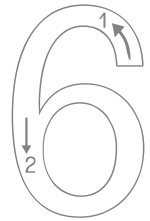
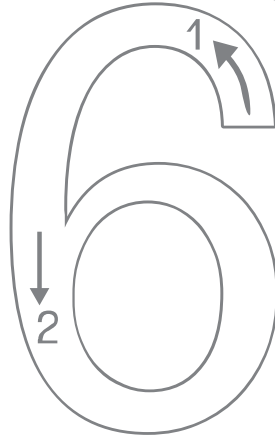
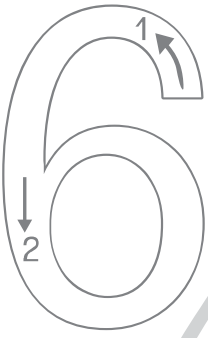

sechs

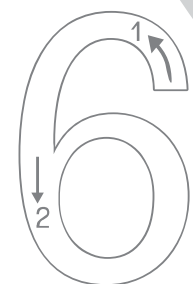

Immer 6 in einem Sack!

3 2 5
4 2 1
3 4 0
4 1 5 3
2 0 3 6 3
5 3 2 3
1 6 3 4 1

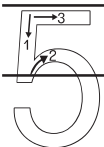

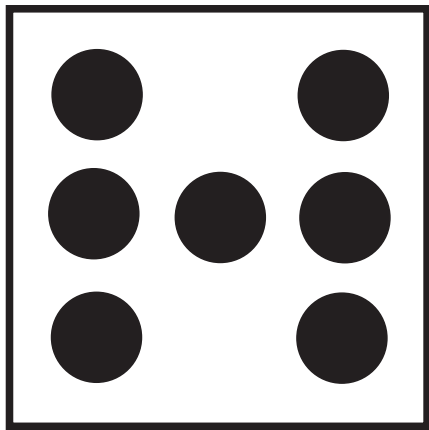

sieben

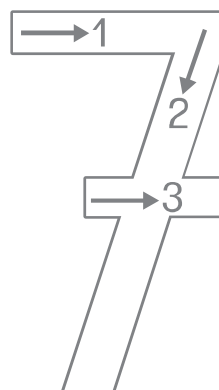
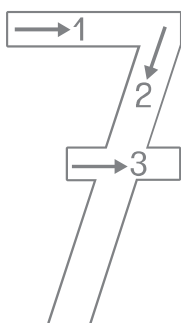
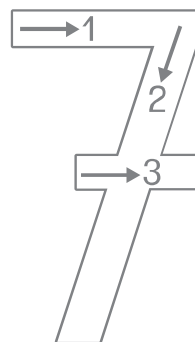
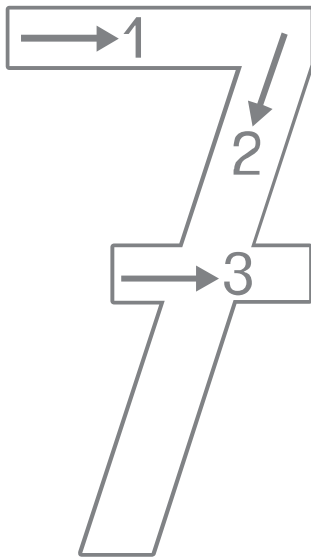

Schau auf die Unterseite des Würfels!

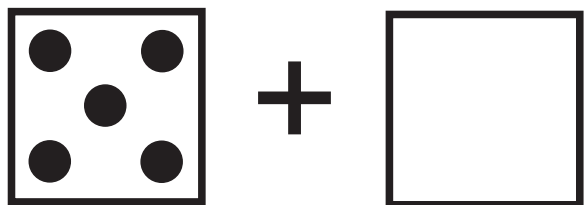

$5 + \text{[empty box]}$

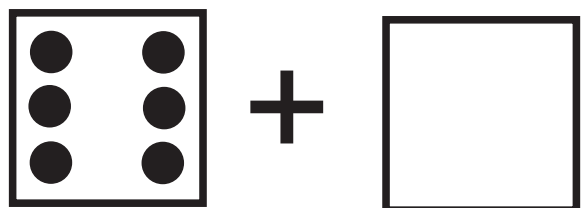

$6 + \text{[empty box]}$

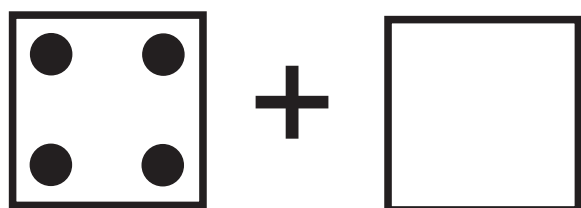

$4 + \text{[empty box]}$

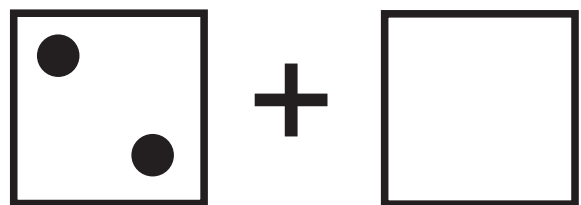

$2 + \text{[empty box]}$

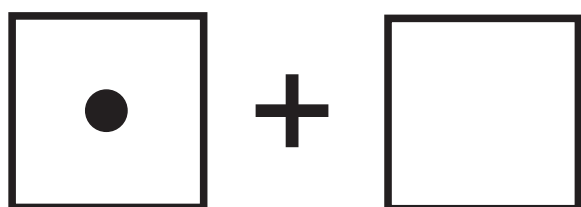

$1 + \text{[empty box]}$

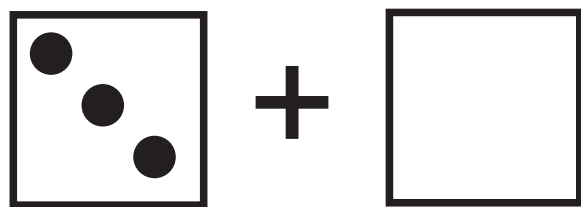

$3 + \text{[empty box]}$

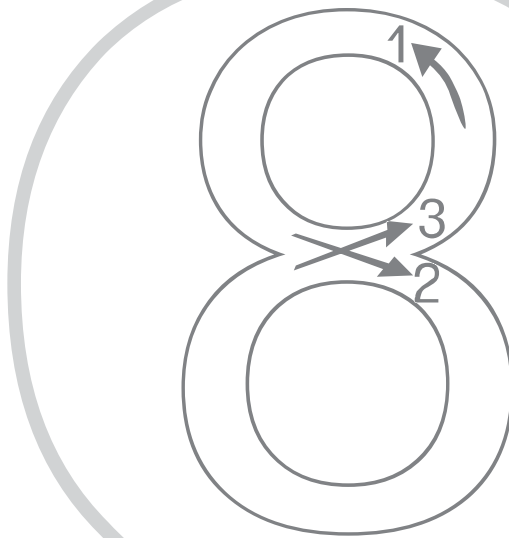
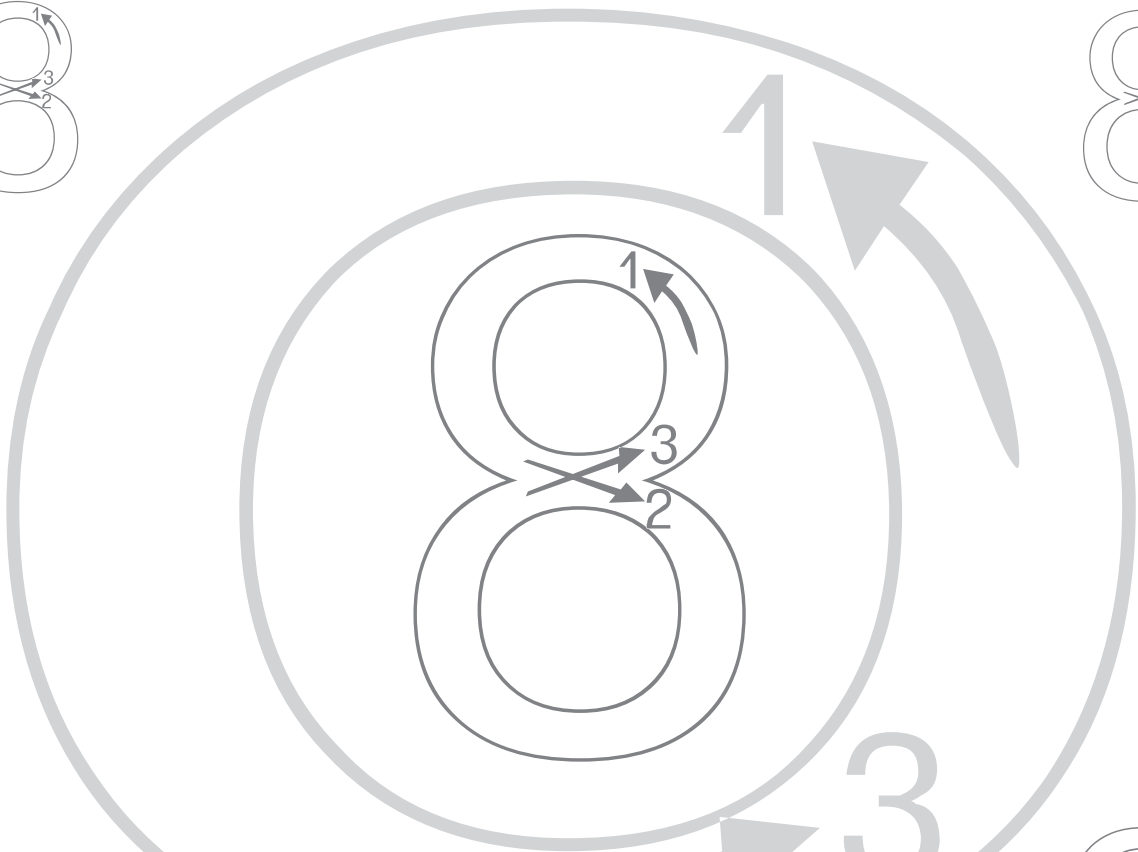
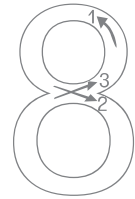
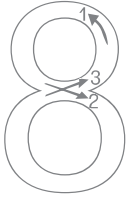

3



2

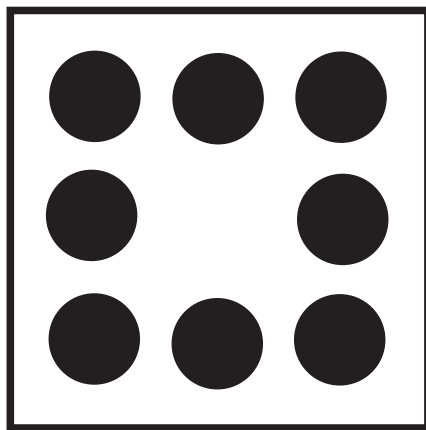
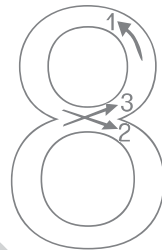

acht

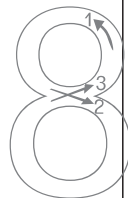
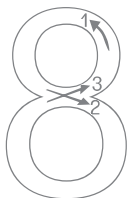

Üben, üben, üben!

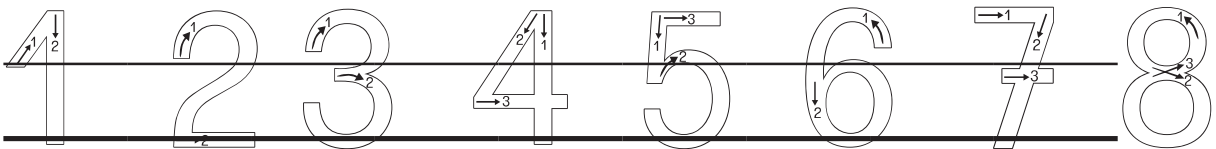
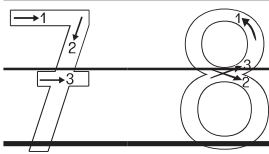
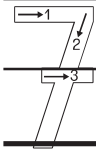
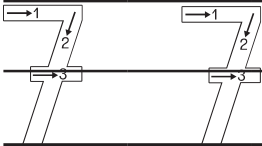
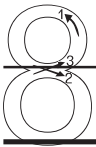
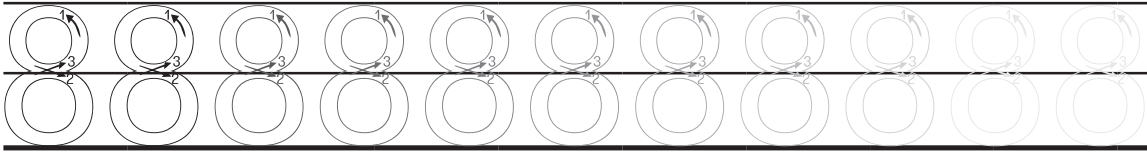

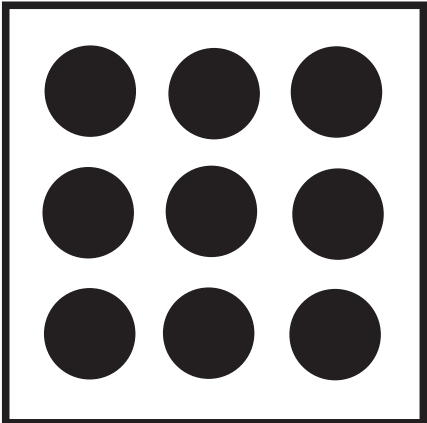
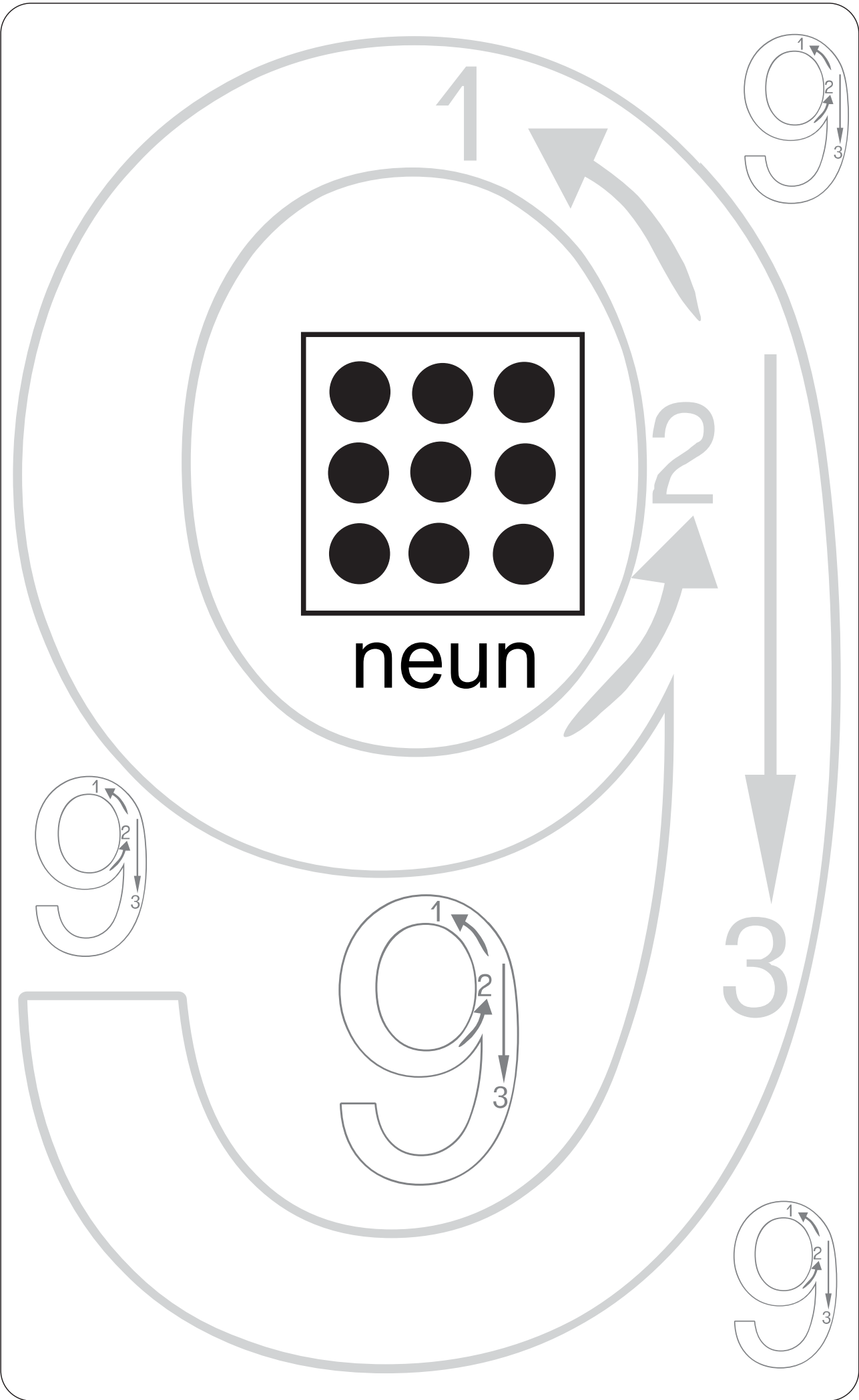

neun

Zähle die Augen des Würfels!

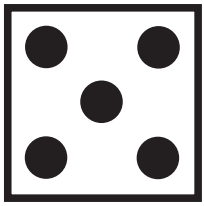

5

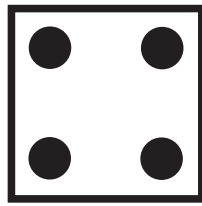
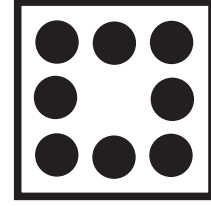
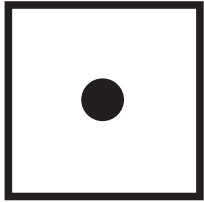
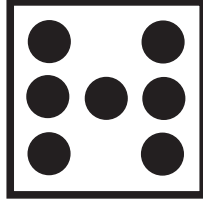
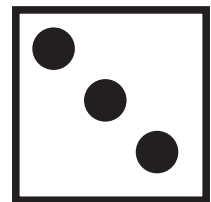
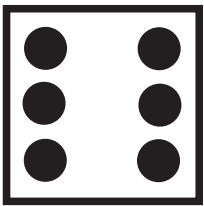
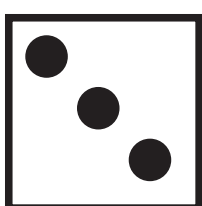
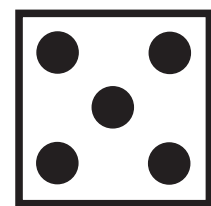
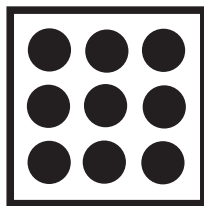
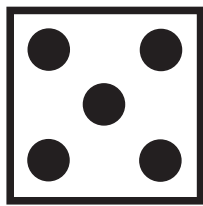
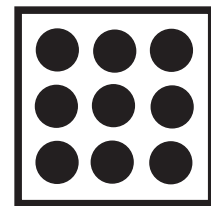
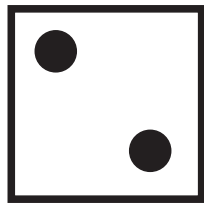
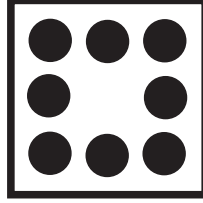
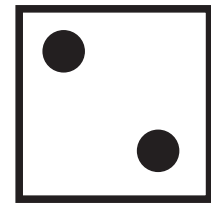
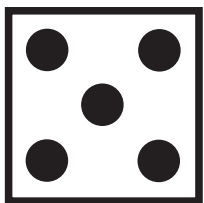
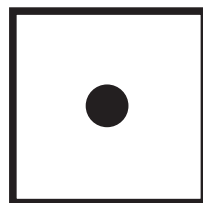
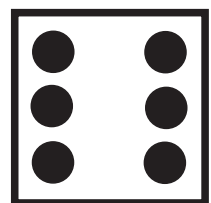
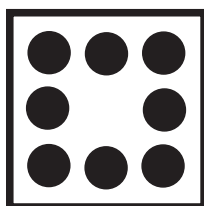
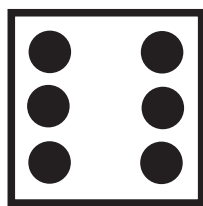
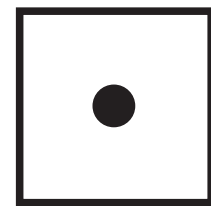
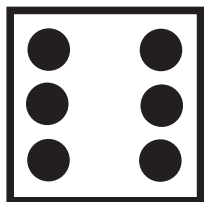
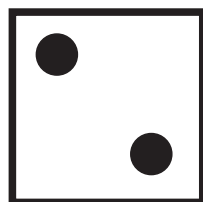
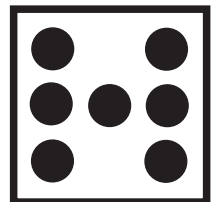
Streiche falsche 1 durch!

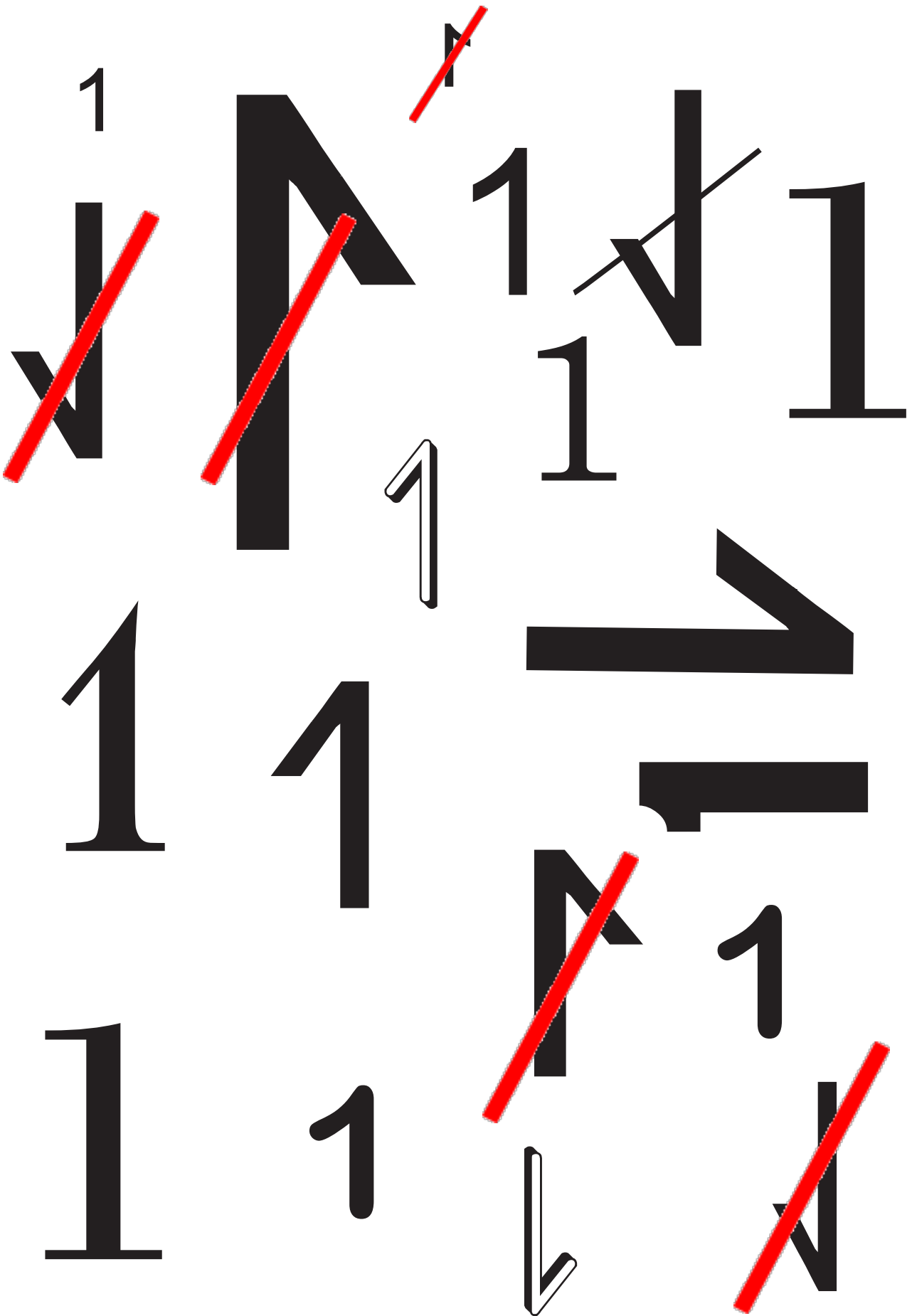

Aus einem mach 2!

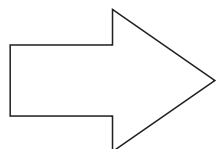
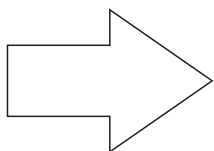
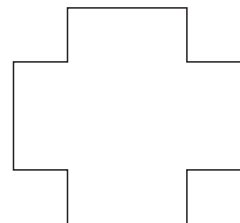
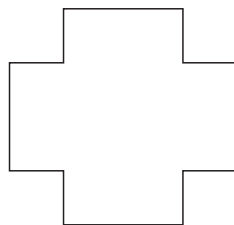
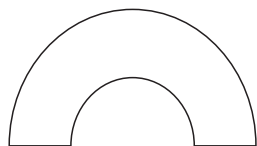
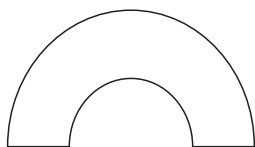
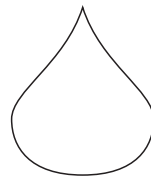
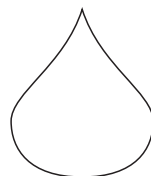
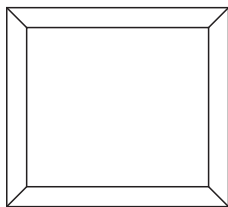
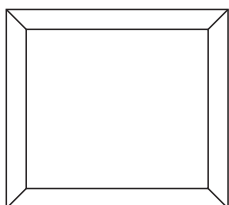
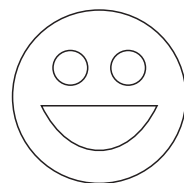
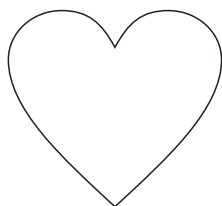
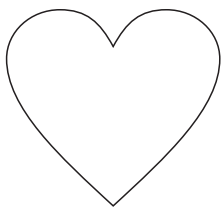
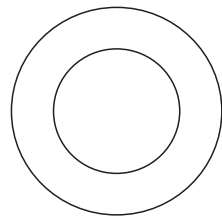
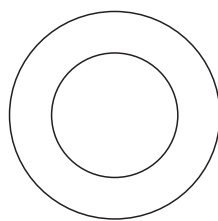
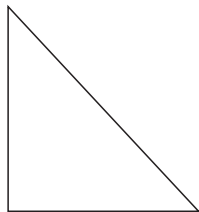
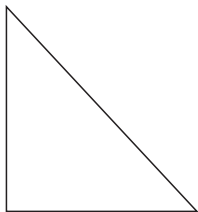
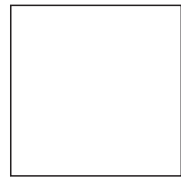
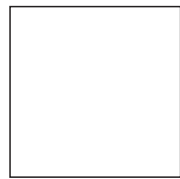
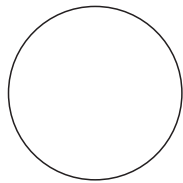
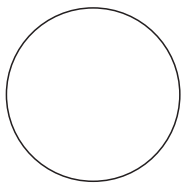

Packe immer 3 in einen Sack!



Wie viel fehlen bis 5?



$$2 + \boxed{3}$$



$$1 + \boxed{4}$$



$$4 + \boxed{1}$$



$$3 + \boxed{2}$$



$$0 + \boxed{5}$$



$$5 + \boxed{0}$$

Immer 6 in einem Sack!

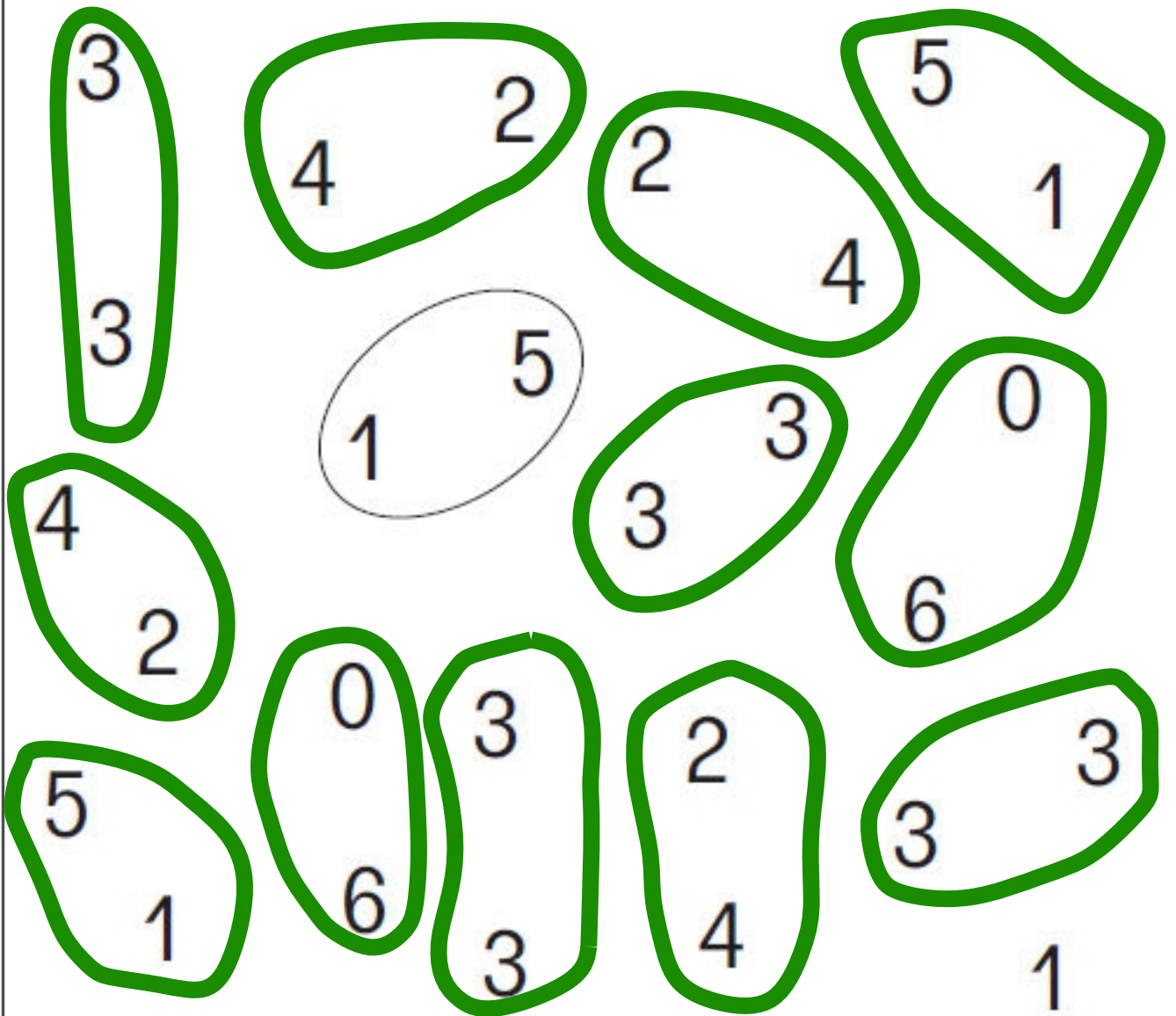

Schau auf die Unterseite des Würfels!

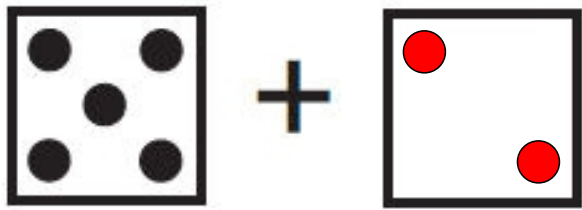

$5 + \boxed{2}$

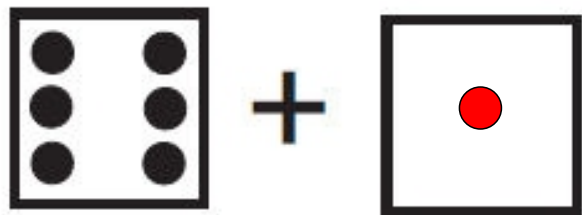

$6 + \boxed{1}$

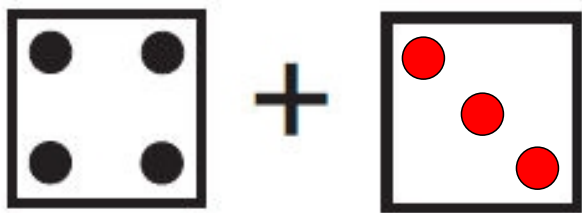

$4 + \boxed{3}$

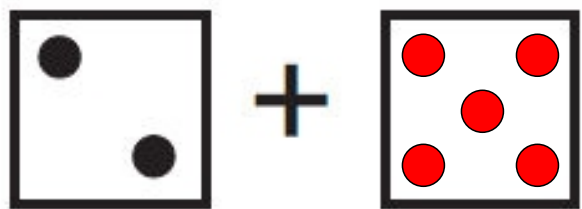

$2 + \boxed{5}$



$1 + \boxed{6}$

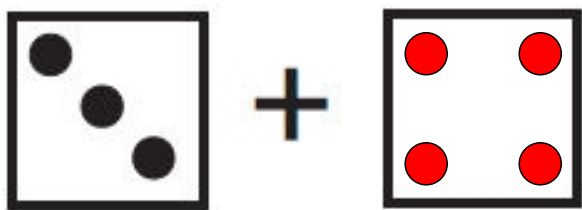

$3 + \boxed{4}$

Zähle die Augen des Würfels!



5



4

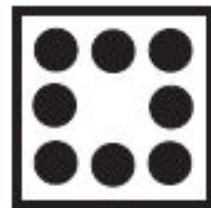

8

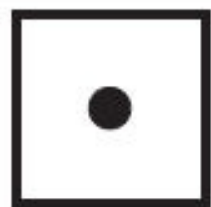

1



7



3



6



3



5



9



5



9



2



8



2



5



1



6



8



6

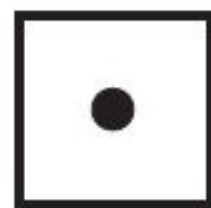

1



6



2

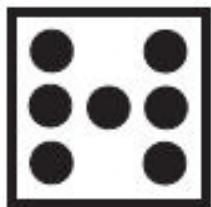

7